

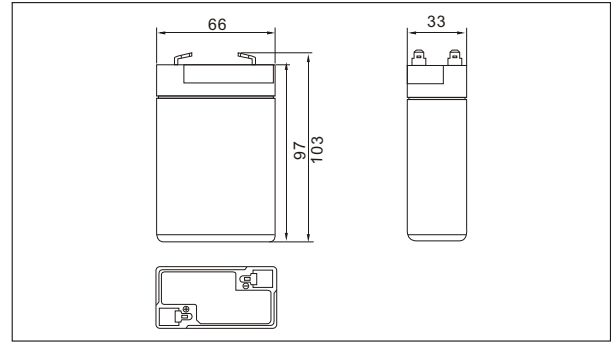

## SW628(6V2.8AH)



### ● Outer dimensions (mm)



### ● Specifications

Nominal Voltage		6 V
Rated capacity (20 hour rate)		2.8 Ah
Dimensions	Total Height	103 mm(4.06inches)
	Height	97 mm(3.82inches)
	Length	66 mm(2.60inches)
	Width	33 mm(1.30inches)
Weight Approx		0.58 Kg (1.28 lbs)

### ● Terminal Type (mm)

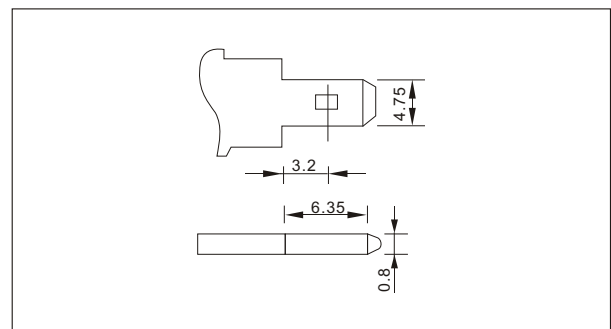

### ● Characteristics

Capacity 25°C(77°F)	20 hour rate(0.14A)	2.80 AH
	10 hour rate(0.26A)	2.60 AH
	5 hour rate(0.48A)	2.40AH
	1 hour rate(1.68A)	1.68 AH
	1.5 hour discharge to 5.25 V	1.12 A
Internal Resistance	Full charged Battery at 25°C(77°F)	30 mΩ
Capacity affected by Temperature (20hour rate)	40°C(104°F)	102%
	25°C(77°F)	100%
	0°C(32°F)	85%
	-15°C(5°F)	65%
Self-Discharge at 25°C(77°F)	Capacity after 3 month storage	91%
	Capacity after 6 month storage	82%
	Capacity after 12 month storage	64%
Terminal		T0
Charge (constant Voltage)	Cycle	Initial Charging Current less than 1.12A Voltage 7.05-7.20V
	Float	Voltage 6.75-6.90V

### ● Discharge Curves 25°C(77°F)

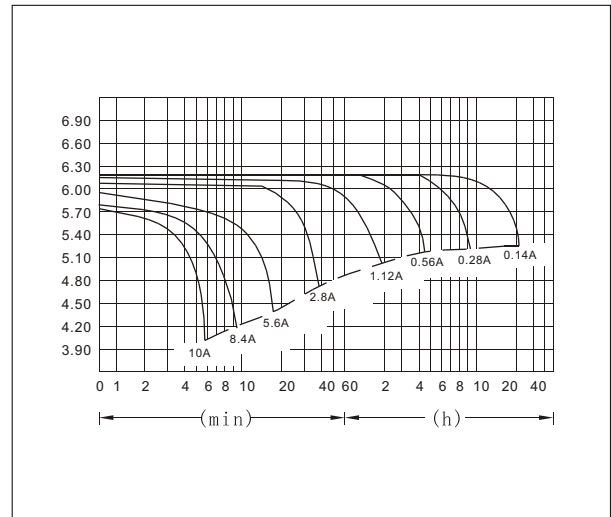

Constant Current(Amp) and Constant Power(Watt) Discharge Table at 25°C(77°F)													
Time		5min	10min	15min	30min	1h	2h	3h	4h	5h	8h	10h	20h
4.80V	A	10.1	6.61	4.90	3.22	1.68	0.98	0.72	0.58	0.49	0.32	0.26	0.14
	W	52.3	35.5	26.3	17.3	9.07	5.38	4.01	3.26	2.79	1.86	1.53	0.84
5.10V	A	9.24	6.32	4.50	3.06	1.58	0.94	0.70	0.56	0.48	0.32	0.26	0.14
	W	49.6	35.3	25.2	17.2	8.92	5.42	4.05	3.26	2.81	1.86	1.53	0.83
5.25V	A	8.41	5.91	4.20	2.96	1.53	0.92	0.69	0.53	0.48	0.32	0.26	0.14
	W	46.2	33.6	24.0	17.1	8.84	5.34	4.01	3.11	2.81	1.85	1.52	0.83
5.40V	A	8.08	5.65	3.92	2.88	1.47	0.90	0.68	0.52	0.46	0.31	0.25	0.14
	W	45.3	32.6	22.6	16.7	8.58	5.26	3.99	3.09	2.69	1.82	1.49	0.81
5.55V	A	7.48	5.32	3.64	2.80	1.42	0.88	0.64	0.51	0.44	0.30	0.25	0.13
	W	42.4	30.8	21.2	16.4	8.37	5.17	3.81	3.06	2.60	1.79	1.48	0.81